

# LEA

SLIMTECH



# SLIMTECH

**UN PICCOLO  
SPESSORE  
PER AMPLIARE  
I VOSTRI  
ORIZZONTI**

**A SMALL  
THICKNESS TO  
BROADEN YOUR  
HORIZONS**



## Grande e potente come la pietra.

Slimtech è la nuova, grande superficie realizzata da Lea Ceramiche.

**Una lastra sottilissima di soli 3 mm con dimensioni record, fino a 300x100 cm.**

Resistente, grande, planare, sottile e leggera, facile, affidabile, garantita, ecologica.

## As large and strong as stone.

Slimtech is the new, large surface created by Lea Ceramiche.

**A very thin slab, only 3 mm thick, with a record size, up to 300x100 cm.**

Resistant, large, flat, thin and light, easy, reliable, guaranteed, ecological.

# \* Tre tipologie di bellezza.

Slimtech è disponibile  
in tre versioni.

- \* **Slimtech 3mm,**  
solo per rivestimenti.
- \* **Slimtech Plus 3,5mm,**  
rinforzata con stuoia in fibra di vetro.
- \* **Slimtech Twin 7mm,**  
a doppio strato con stuoia,  
ad alta resistenza.

## Three types of beauty.

Slimtech is available  
in three versions.

- \* **Slimtech thickness 3mm,**  
only for wall covering.
- \* **Slimtech Plus thickness 3,5mm,**  
reinforced with a sheet of fiberglass.
- \* **Slimtech Twin thickness 7mm,**  
with a double layer divided by a sheet of fiberglass,  
with very high resistance.





## Per rinnovare il pavimento e semplificarsi la vita.

Slimtech è ideale per  
il rinnovo dei pavimenti.

**La lastra sottile può  
essere semplicemente  
sovrapposta alla  
vecchia superficie,**  
evitando così la  
demolizione e la  
produzione di detriti.

**I tempi di installazione  
vengono ridotti;**  
le porte esistenti non  
devono essere tagliate  
o limate. Tutto è più  
semplice, tutto è più  
veloce.

**To renew  
the floor  
and simplify  
one's life.**

Slimtech is ideal  
for the renovation of floors.

**The slender slab can  
simply be placed over  
the old surface,**  
thus avoiding demolition  
and waste .

**Installation time  
is reduced;**  
the existing doors do not  
have to be cut or filed.  
Everything  
is simpler, everything is  
faster.



## Nuova nella tecnologia attenta all'ecologia.

Slimtech è frutto di una  
**tecnologia innovativa  
di compattazione del  
gres porcellanato.**  
Viene prodotta in lastre  
interi di 300x100 cm  
senza l'impiego di stampi  
e pressata su un tappeto  
**con una forza di  
15.000 tonnellate.**

La cottura avviene in  
**forni che abbattano  
le emissioni e la  
dispersione di polveri  
sottili;** le materie prime  
sono selezionate e  
purissime.

**New  
technology,  
conscious  
of the ecology.**

Slimtech is the result  
of a **new innovative  
technology of compaction  
of porcelain stoneware.**  
It is manufactured in whole  
slabs of 300x100 cm without  
the use of moulds and  
pressed onto a carpet  
**with a force of  
15,000 tons.**

The firing is done in  
**ovens that reduce  
emissions and the  
dispersal of fine dust;**  
the raw materials are selected  
with care and very pure.



## Minime le fughe, massima la semplicità.

Grazie al suo ridotto spessore, Slimtech è facile da installare. Consente una grande precisione e continuità del piano di pavimento.

**Riduce le fughe e di conseguenza i problemi di manutenzione e di igienizzazione negli ambienti pubblici.**

## Minimum joints, maximum simplicity.

Thanks to the reduced thickness, Slimtech is easy to install. It allows great precision and continuity of the floor level.  
**Reduces joints and consequently the problems of maintenance and hygiene in public spaces.**

# SLIMTECH

- **GRES LAMINATO UGL**

Laminated stoneware UGL  
Grès laminé UGL  
Laminiertes Feinsteinzeug UGL  
Gres laminado UGL

- **FORMATI / SIZES**

**GOUACHE.10 - BASALTINA STONE PROJECT - SHADE - ARENARIA**  
3000x1000mm / 118.1x39.4"  
1000x1000mm 1000x500mm 500x500mm / 39.4x39.4" - 39.4x19.7" - 19.7x19.7"  
1000x49mm / 39.4x1.9"

- **WAVES - LINES**

3000x1000mm / 118.1x39.4"

- **MAUK**

spina 135x258x87mm / 5.3x10.1x3.4"  
esa 383mm / 15"  
cuadra 576mm / 22.6"

- **STONALIZZAZIONE**

Shading  
Denuançage  
Spielfarbig  
Grado de tonalización

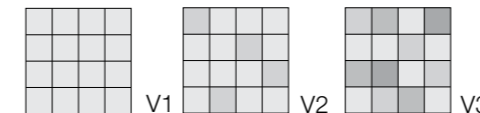

**WAVES / LINES / SHADE V1**  
**GOUACHE.10 / ARENARIA V2**  
**BASALTINA / MAUK V3**

- **SPESSORE**

Thickness  
Epaisseur  
Stärke  
Espesor

**WAVES / LINES** 3,5 mm slimtech plus  
**GOUACHE.10** 3 mm slimtech / 3,5 mm slimtech plus / 7 mm slimtech twin  
**BASALTINA** 3 mm slimtech / 3,5 mm slimtech plus / 7 mm slimtech twin  
**MAUK** 3 mm slimtech / 3,5 mm slimtech plus  
**SHADE** 3 mm slimtech / 3,5 mm slimtech plus / 7 mm slimtech twin  
**ARENARIA** 3 mm slimtech / 3,5 mm slimtech plus / 7 mm slimtech twin

- **FUGA MINIMA CONSIGLIATA PER POSA IN INTERNO**

Minimum suggested joint for indoor installation  
Joint minimum conseillé pour pose en enterieure  
Empfohlene Fugenbreite fuer Innenbereich  
Junta mínima aconsejada para colocación en interior

1 mm slimtech - slimtech plus: Parete / Wall / Mur / Wand / Revestimiento  
2 mm slimtech plus - slimtech twin: Pavimento / Floor / Sol / Boden / Pavimento  
3 mm slimtech plus 3000x1000 mm: Pavimento / Floor / Sol / Boden / Pavimento

# WAVES

design Patrick Norguet

- **FORMATO / SIZE**  
3000x1000mm slimtech plus 1890



100x300cm  
39.4x118.1"

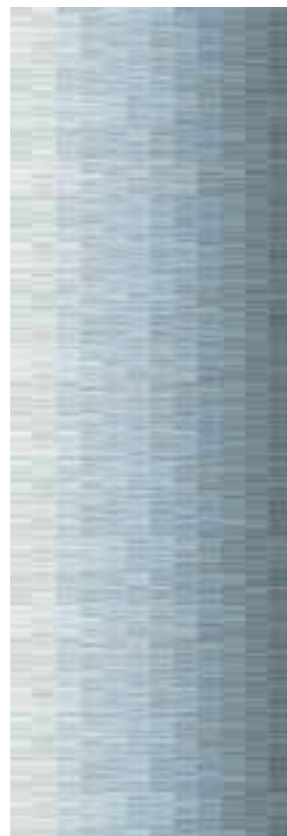

WAVE BLUE A 100x300cm / 39.4x118.1"



WAVE GREEN A 100x300cm / 39.4x118.1"



WAVE GREY A 100x300cm / 39.4x118.1"



WAVE BLUE B 100x300cm / 39.4x118.1"



WAVE GREEN B 100x300cm / 39.4x118.1"



WAVE GREY B 100x300cm / 39.4x118.1"

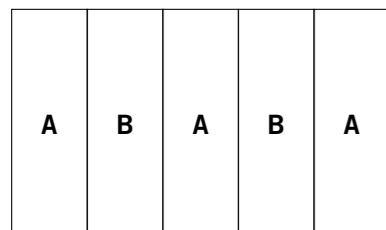

# LINES

design Patrick Norguet

- **FORMATO / SIZE**  
3000x1000mm slimtech plus 1890



100x300cm  
39.4x118.1"



LINE BLUE 100x300cm / 39.4x118.1"



LINE YELLOW 100x300cm / 39.4x118.1"



LINE GREY 100x300cm / 39.4x118.1"







# GOUACHE.10

design Diego Grandi

## • FORMATI / SIZES

3000x1000mm slimtech - slimtech plus - slimtech twin\*  
1000x500mm slimtech - slimtech plus - slimtech plus douce  
1000x1000mm 500x500mm 1000x49mm slimtech plus

\*su richiesta / upon request / sur demande / auf Anfrage / bajo pedido

slimtech slimtech plus slimtech twin*	1560 1810	slimtech plus 1750	slimtech slimtech plus slimtech plus douce	1400 1620 1820	slimtech plus 1620	slimtech plus 1930
						
300x100cm 118.1x39.4"		100x100cm 39.4x39.4"	50x100cm 19.7x39.4"	50x50cm 19.7x19.7"	4,9x100cm 1.9x39.4"	

## • COLORI / COLORS



# GOUACHE.10

design Diego Grandi

## • COLORI / COLORS



## • DECORO LIBECCIO

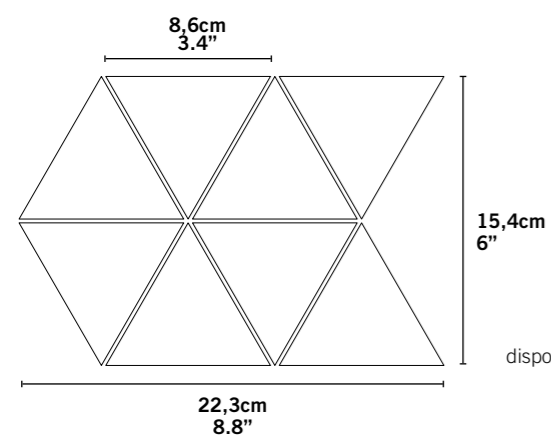

disponibile in tutti i colori / available in all colors [0330](#)

libeccio 01WARM



libeccio 01COOL



libeccio 02



libeccio 03





# BASALTINA STONE PROJECT

## • FORMATI / SIZES

3000x1000mm slimtech - slimtech plus - slimtech twin\*  
 1000x1000mm 500x500mm slimtech plus  
 1000x500mm 1000x49mm slimtech - slimtech plus

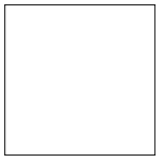
\*su richiesta / upon request / sur demande / auf Anfrage / bajo pedido

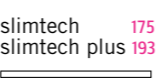
slimtech slimtech plus slimtech twin*	1560 1810	slimtech plus 1750	slimtech slimtech plus	1400 1620	slimtech plus 1620	slimtech slimtech plus	1750 1930
							
300x100cm 118.1x39.4"		100x100cm 39.4x39.4"	50x100cm 19.7x39.4"	50x50cm 19.7x19.7"	4,9x100cm 1.9x39.4"		

## • COLORI / COLORS

			
sabbia	naturale	stuccata	lappata

## • MOSAICI

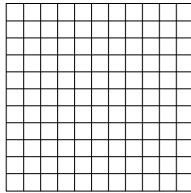
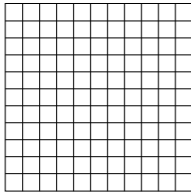
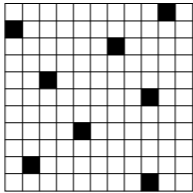
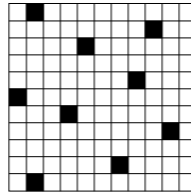
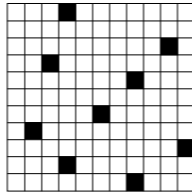
				
*MOSAICO QUADRO 25x25cm 9.8x9.8" 0330	*MOSAICO MATTONE 25x25cm 9.8x9.8" 0240	*MOSAICO INOX 25x25cm 9.8x9.8" 0750	MOSAICO SATIN 25x25cm 9.8x9.8" sabbia / naturale 0750	MOSAICO PEARL 25x25cm 9.8x9.8" stuccata / lappata 0750

*MOSAICO LISTELLO 50x25cm 19.7x9.8" 0390

*MOSAICO STRISCIA 50x25cm 19.7x9.8" 0470

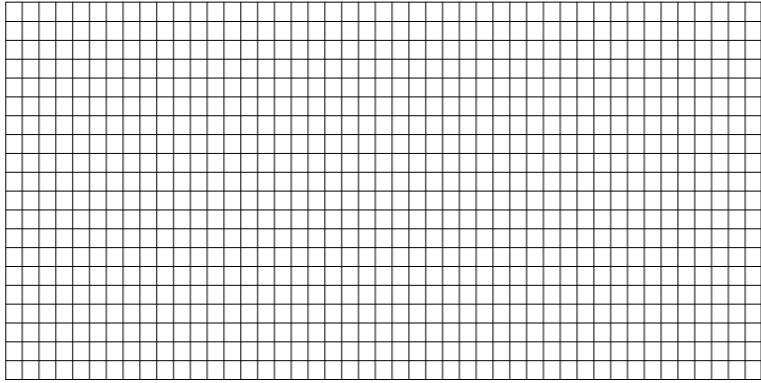
MOSAICO GLITTER chiaro (sabbia) / scuro (stuccata) 100x50cm 39.4x19.7" 2090
MOSAICO METAL chiaro (naturale) / scuro (lappata) 100x50cm 39.4x19.7" 2110

\*Disponibili su tutti i colori della serie.  
 Available in all the color tones of the series.  
 Disponible dans toutes les couleurs de la série.  
 Lieferbar in allen Farben der serie.  
 Disponibles en todos los colores de la serie.



# MAUK

design Diego Grandi

## MAUK SPINA

### • FORMATI / SIZES

135mm base minore - 5.3"  
258mm base maggiore - 10.1"  
87mm lati - 3.4"

0030

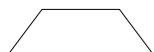

### • COLORI / COLORS



bsp slimtech sabbiata



bsp slimtech lappata

## MAUK ESA

### • FORMATI / SIZES

383mm lati - 15"

0240

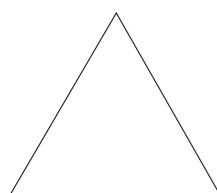

### • COLORI / COLORS



bsp slimtech plus naturale



bsp slimtech plus lappata

## MAUK CUADRA

### • FORMATI / SIZES

576mm lati - 22.6"

0810

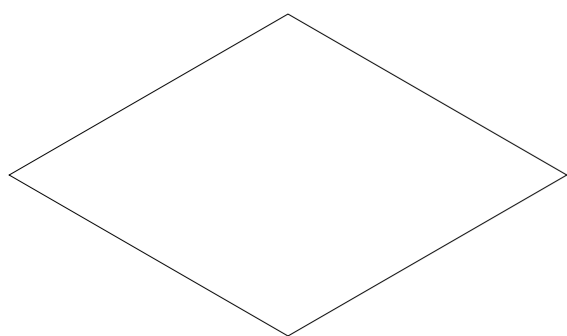

### • COLORI / COLORS



bsp slimtech plus sabbiata



bsp slimtech plus naturale



bsp slimtech plus lappata



# SHADE

## • FORMATI / SIZES

3000x1000mm slimtech - slimtech plus - slimtech twin\*  
 1000x1000mm 500x500mm 1000x49mm slimtech plus  
 1000x500mm slimtech - slimtech plus - slimtech douce

\*su richiesta / upon request / sur demande / auf Anfrage / bajo pedido

slimtech 1560  
 slimtech plus 1810  
 slimtech twin\*



300x100cm  
 118.1x39.4"

slimtech plus 1750



100x100cm  
 39.4x39.4"

slimtech 1400  
 slimtech plus 1620  
 slimtech douce 1820



50x100cm  
 19.7x39.4"

slimtech plus 1620



50x50cm  
 19.7x19.7"

slimtech plus 1930



4,9x100cm  
 1.9x39.4"

## • COLORE / COLOR

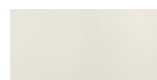

milk

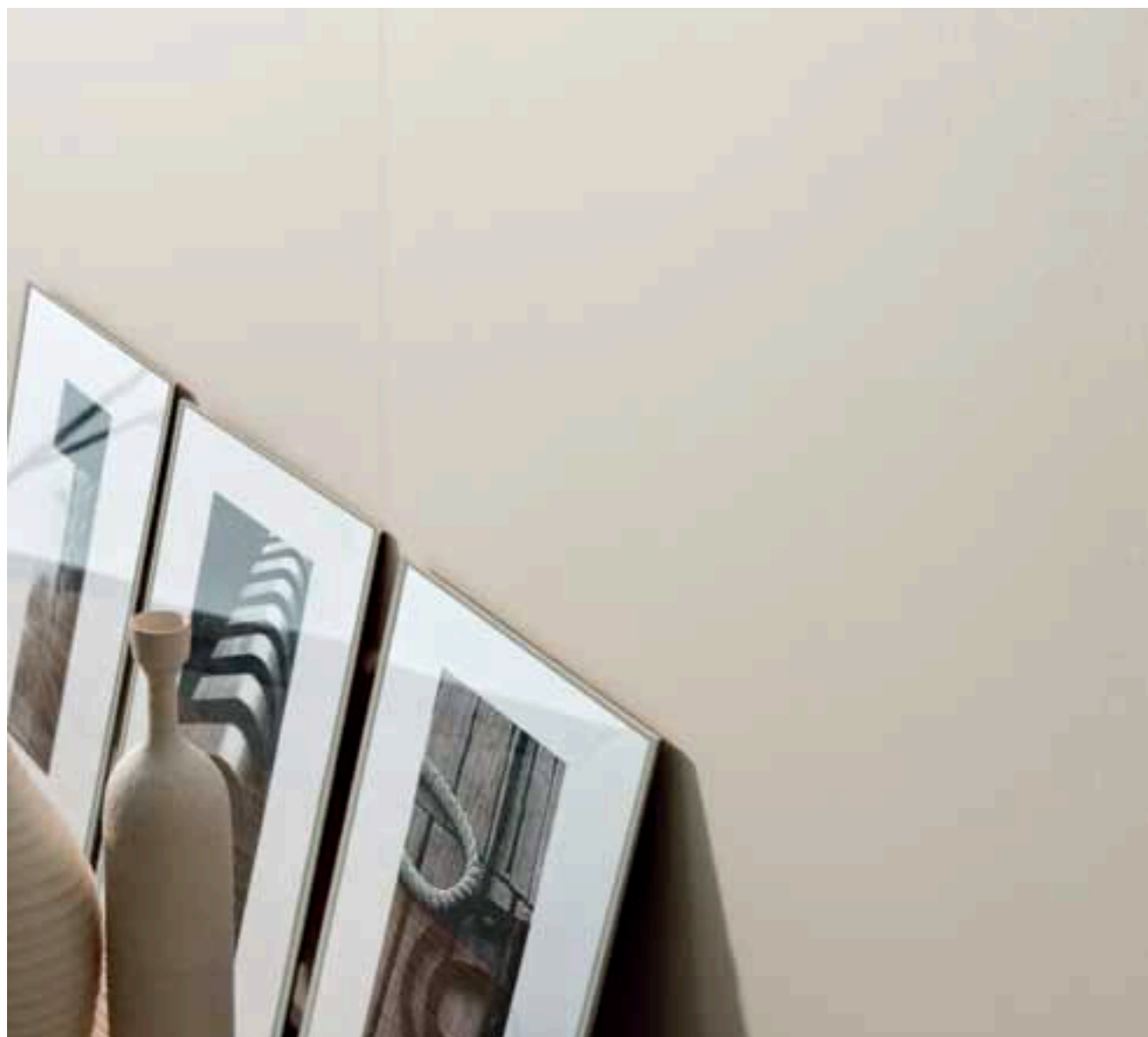

# ARENARIA

## • FORMATI / SIZES

3000x1000mm slimtech - slimtech plus - slimtech twin\*  
 1000x1000mm 500x500mm slimtech plus  
 1000x500mm 1000x49mm slimtech - slimtech plus

\*su richiesta / upon request / sur demande / auf Anfrage / bajo pedido

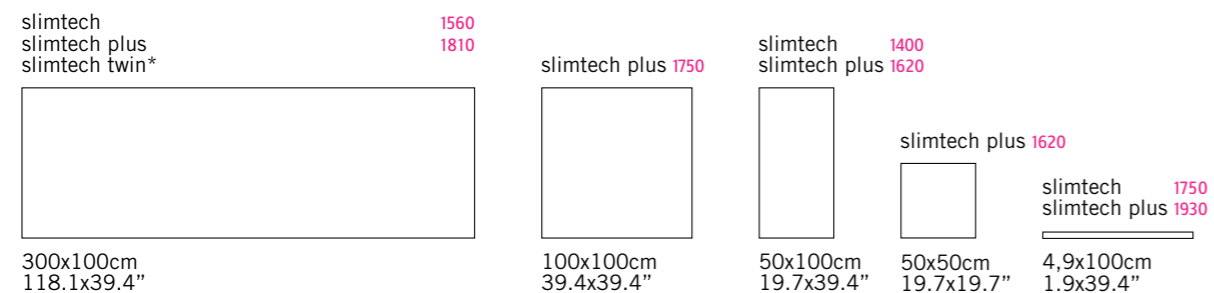

## • COLORI / COLORS

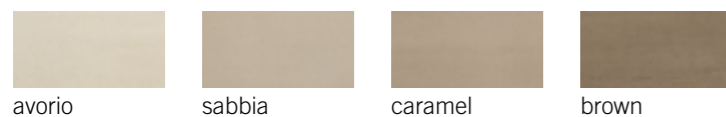

# ARENARIA

## • COLORI / COLORS

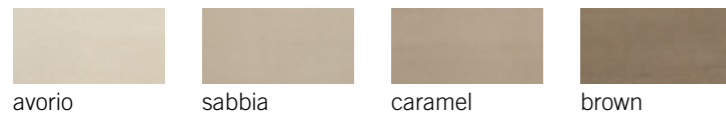

## • DECORO BAMBOO



50x100cm 19.7x39.4"

1850

## • MOSAICI

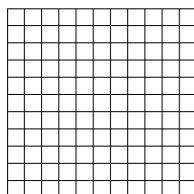

\*MOSAICO QUADRO  
25x25cm 9.8x9.8" 0330

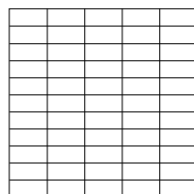

\*MOSAICO MATTONE  
25x25cm 9.8x9.8" 0240

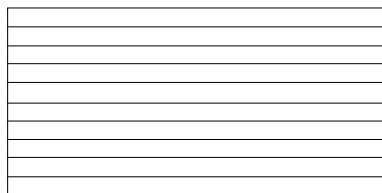

\*MOSAICO STRISCIA  
50x25cm 19.7x9.8" 0470

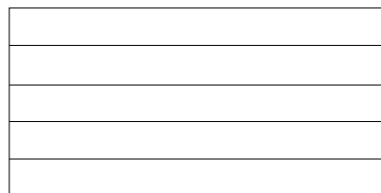

\*MOSAICO LISTELLO  
50x25cm 19.7x9.8" 0390

\*Disponibili su tutti i colori della serie.  
Available in all the color tones of the series.  
Disponible dans toutes les couleurs de la série.  
Lieferbar in allen Farben der serie.  
Disponibles en todos los colores de la serie.



## SLIMTECH

### CARATTERISTICHE TECNICHE TECHNICAL CHARACTERISTICS CARACTÉRISTIQUES TECHNIQUES TECHNISCHE EIGENSCHAFTEN CARACTERÍSTICAS TÉCNICAS

metodo di prova iso  
test method iso  
méthode d'essai iso  
prüfmethode iso  
método de prueba iso

requisiti prescritti  
required values / valeurs requises  
vorgeschriebener wert  
requisitos prescritos  
iso 13006 - G / en 14411 - G  
bla ugl

	<b>assorbimento d'acqua</b> water absorption absorption d'eau wasserabsorption absorción de agua	iso 10545-3	≤ 0,5%
	<b>resistenza al gelo</b> frost resistance résistance au gel frostbeständigkeit resistencia al hielo	iso 10545-12	nessuna alterazione no alterations
	<b>resistenza alla flessione</b> bending strength résistance à la flexion beigefestigkeit resistencia a la flexión	iso 10545-4	≥ 35 N/mm <sup>2</sup>
	<b>sforzo di rottura (S)</b> breaking strength (S) chargement de rupture (S) bruchlast (S) esfuerzo de rotura (s)	iso 10545-4	≥ 700 N
	<b>resistenza all'abrasione profonda</b> resistance to deep abrasion résistance à l'abrasion profonde widerstand gegen tiefenabrieb resistencia a la abrasión profunda	iso 10545-6	≤ 175 mm <sup>3</sup>
	<b>resistenza a compressione</b> resistance to compression résistance à la compression druckfestigkeit resistencia a compresión	-	-
	<b>resistenza agli sbalzi termici</b> thermal shock resistance résistance aux choc thermique temperaturwechselbeständigkeit resistencia a los cambios térmico	iso 10545-9	resistente resistant résistant beständig resistente
	<b>resistenza attacco chimico</b> chemical resistance résistance chimique chemischee beständigkeit resistencia unión química	iso 10545-13	come indicato dal produttore as indicated by manufacturer
	<b>resistenza alle macchie</b> stain resistance résistance aux taches fleckenbeständigkeit resistencia a las manchas	iso 10545-14	≥ classe 3
	<b>resistenza allo scivolamento</b> slip resistance résistance au glissement rutschfestigkeit resistencia al deslizamiento	din 51130	r9 6° ≤ α ≤ 10°
	<b>coefficiente di attrito dinamico</b> dynamic friction coefficient coefficient de friction dynamique dynamischer reibungskoeffizient coeficiente de fricción dinámica	b.c.r.	>0,40 L. 13/89 - DM. 236/89 D. Lgs 503/96
	<b>coefficient of friction (c.o.f.)</b>	astm c1028	COF < 0,50 questionable 0.50 ≤ COF < 0.50 conditionally slip resistant COF ≥ 0.60 slip resistant

### IMPIEGHI USES EMPLOI ANWENDUNGSBEREICHE EMPLEOS

	<b>alberghi</b> hotels hotels hoteles		<b>locali pubblici</b> public spaces lieux publics öffentliche bereiche locales públicos		<b>negozi</b> shops magasins geschäfte tiendas
	<b>abitazioni</b> housing maisons wohnbereiche viviendas		<b>aeroporti</b> airports aerports flughafen aeropuertos		<b>stazioni</b> train stations gares bahnhöfe estaciones
	<b>bar - ristoranti</b> bar - restaurants bar - restaurants cafés - restaurants, gasthäuser bar - restaurantes		<b>centri commerciali</b> malls centre commerciaux einkaufszentren centros comerciales		

## SLIMTECH

slimtech

slimtech plus













slimtech twin

### CARATTERISTICHE TECNICHE TECHNICAL CHARACTERISTICS CARACTÉRISTIQUES TECHNIQUES TECHNISCHE EIGENSCHAFTEN CARACTERÍSTICAS TÉCNICAS

spessore 3mm  
thickness  
épaisseur  
stärke  
espesor

spessore 3,5 mm  
thickness  
épaisseur  
stärke  
espesor

spessore 7 mm  
thickness  
épaisseur  
stärke  
espesor

	<b>assorbimento d'acqua</b> water absorption absorption d'eau wasserabsorption absorción de agua	≤0,1%	≤0,1%*	≤0,1%*
	<b>resistenza al gelo</b> frost resistance résistance au gel frostbeständigkeit resistencia al hielo	resistente resistant résistant beständig resistente	resistente resistant résistant beständig resistente	resistente resistant résistant beständig resistente
	<b>resistenza alla flessione</b> bending strength résistance à la flexion beigefestigkeit resistencia a la flexión	≥ 35 N/mm <sup>2</sup>	≥ 120 N/mm <sup>2**</sup>	≥ 55 N/mm <sup>2**</sup>
	<b>sforzo di rottura (S)</b> breaking strength (S) chargement de rupture (S) bruchlast (S) esfuerzo de rotura (s)	non richiesto materiale da rivestimento not required wall tiles	≥ 1000 N**	≥ 1800 N**
	<b>resistenza all'abrasione profonda</b> resistance to deep abrasion résistance à l'abrasion profonde widerstand gegen tiefenabrieb resistencia a la abrasión profunda	≤ 145 mm <sup>3</sup>	≤ 145 mm <sup>3</sup>	≤ 145 mm <sup>3</sup>
	<b>resistenza a compressione</b> resistance to compression résistance à la compression druckfestigkeit resistencia a compresión	non richiesto materiale da rivestimento not required wall tiles	≥ 4000 Kg/cm <sup>2</sup> ≥ 400 N/mm <sup>2</sup>	≥ 4000 Kg/cm <sup>2</sup> ≥ 400 N/mm <sup>2</sup>
	<b>resistenza agli sbalzi termici</b> thermal shock resistance résistance aux choc thermique temperaturwechselbeständigkeit resistencia a los cambios térmico	resistente resistant résistant beständig resistente	resistente resistant résistant beständig resistente	resistente resistant résistant beständig resistente
	<b>resistenza attacco chimico</b> chemical resistance résistance chimique chemischee beständigkeit resistencia unión química	uha, ula resistente resistant résistant beständig resistente	uha, ula resistente resistant résistant beständig resistente	uha, ula resistente resistant résistant beständig resistente
	<b>resistenza alle macchie</b> stain resistance résistance aux taches fleckenbeständigkeit resistencia a las manchas	5 resistente resistant résistant beständig resistente	5 resistente resistant résistant beständig resistente	5 resistente resistant résistant beständig resistente
	<b>resistenza allo scivolamento</b> slip resistance résistance au glissement rutschfestigkeit resistencia al deslizamiento	non richiesto materiale da rivestimento not required wall tiles	r9 escluso douce except douce	r9 escluso douce except douce
	<b>coefficiente di attrito dinamico</b> dynamic friction coefficient coefficient de friction dynamique dynamischer reibungskoeffizient coeficiente de fricción dinámica	non richiesto materiale da rivestimento not required wall tiles	>0,40 cuoio - asciutto / gomma - bagnato leather - dry / rubber - wet cuir - sec / caoutchouc - mouillé leder - seco / goma - mojado escluso douce / except douce	>0,40 cuoio - asciutto / gomma - bagnato leather - dry / rubber - wet cuir - sec / caoutchouc - mouillé leder - seco / goma - mojado escluso douce / except douce
	<b>coefficient of friction (c.o.f.)</b>	not required wall tiles	dry - neolite ≥ 0.60 wet - neolite ≥ 0.60 except douce	dry - neolite ≥ 0.60 wet - neolite ≥ 0.60 except douce

\*VALORE RIFERITO AL MATERIALE CERAMICO  
VALUE REFERRED TO CERAMIC MATERIAL ONLY

\*\*VALORE RIFERITO AL PEZZO COMPLETO (LASTRA E RINFORZO)  
VALUE REFERRED TO THE ALL-IN-ONE PIECE (SLAB AND FIBERGLASS)

**WAVES**

articolo	scatola			europallet				
	pz.	mq	kg	scat.	mq	kg		
fondo plus	300x100	118.1x39.4	1	3,0	25,3	12 pz/pl	36,0	304,2

**LINES**

articolo	scatola			europallet				
	pz.	mq	kg	scat.	mq	kg		
fondo plus	300x100	118.1x39.4	1	3,0	25,3	12 pz/pl	36,0	304,2

**GOUACHE-10**

articolo	scatola			europallet				
	pz.	mq	kg	scat.	mq	kg		
fondo	300x100	118.1x39.4	1	3,0	22,2	13 pz/pl	39,0	288,6
fondo plus	300x100	118.1x39.4	1	3,0	25,3	12 pz/pl	36,0	304,2
fondo plus	100x100	39.4x39.4	3	3,0	24,1	25	75,0	602,5
fondo	100x50	39.x19.7	5	2,5	17,8	32	80,0	569,6
fondo plus	100x50	39.x19.7	5	2,5	20,0	32	80,0	640,0
fondo plus	50x50	19.7x19.7	7	1,75	14,0	48	84,0	672,0
fondo plus	4,9x100	1.9x39.4	10	0,49	4,2	39	19,1	163,8
decoro libeccio	22,3x15,4	6x8.7	10	0,34	2,8	80	27,47	224,0

**BASALTINA STONE PROJECT**

articolo	scatola			europallet				
	pz.	mq	kg	scat.	mq	kg		
fondo	300x100	118.1x39.4	1	3,0	22,2	13 pz/pl	39,0	288,6
fondo plus	300x100	118.1x39.4	1	3,0	25,3	12 pz/pl	36,0	304,2
fondo plus	100x100	39.4x39.4	3	3,0	24,1	25	75,0	602,5
fondo	100x50	39.x19.7	5	2,50	17,8	32	80,0	569,6
fondo plus	100x50	39.x19.7	5	2,50	20,0	32	80,0	640,0
fondo plus	50x50	19.7x19.7	7	1,75	14,0	48	84,0	672,0
fondo	4,9x100	1.9x39.4	10	0,49	4,0	39	19,1	156,0
fondo plus	4,9x100	1.9x39.4	10	0,49	4,2	39	19,1	163,8
mosaico quadro	25x25	9.8x9.8	10	0,62	4,6	60	37,5	276,0
mosaico mattone	25x25	9.8x9.8	10	0,62	4,6	60	37,5	276,0
mosaico striscia	25x50	9.8x19.7	10	1,25	6,9	60	75,0	414,0
mosaico listello	25x50	9.8x19.7	10	1,25	6,9	60	75,0	414,0
mosaico metal	50x100	39.4x19.7	2	1,0	9,9	25	25,0	247,6
mosaico glitter	50x100	39.4x19.7	2	1,0	8,8	25	25,0	220,7
mosaico inox	25x25	9.8x9.8	10	0,62	4,6	60	37,5	276,0
mosaico satin	25x25	9.8x9.8	10	0,62	4,6	60	37,5	276,0
mosaico pearl	25x25	9.8x9.8	10	0,62	4,6	60	37,5	276,0

**MAUK**

articolo	scatola			europallet				
	pz.	mq	kg	scat.	mq	kg		
cuadra plus	57,6	22,6	6	1,73	15,5	5	8,6	77,5
esa plus	38,3	15	12	0,77	6,4	20	15,4	127,0
spina	25,8x13,5x8,7	10.1x5.3x3.4	15	0,18	1,5	80	14,8	120,0

**SHADE**

articolo	scatola			europallet				
	pz.	mq	kg	scat.	mq	kg		
fondo	300x100	118.1x39.4	1	3	22,2	13 pz/pl	39,0	288,6
fondo plus	300x100	118.1x39.4	1	3	25,35	12 pz/pl	36,0	304,2
fondo plus	100x100	39.4x39.4	3	3	24,10	25	75,0	602,5
fondo	100x50	39.4x19.7	5	2,5	17,8	32	80,0	569,6
fondo plus	100x50	39.4x19.7	5	2,5	20,0	32	80,0	640,0
fondo plus	50x50	19.7x19.7	7	1,75	14,0	48	84,0	672,0
fondo plus	4,9x100	1.9x39.4	10	0,49	4,2	39	19,11	163,8

**ARENARIA**

articolo	scatola			europallet				
	pz.	mq	kg	scat.	mq	kg		
fondo	300x100	118.1x39.4	1	3,0	22,2	13 pz/pl	39,0	288,6
fondo plus	300x100	118.1x39.4	1	3,0	25,3	12 pz/pl	36,0	304,2
fondo plus	100x100	39.4x39.4	3	3,0	24,1	25	75,0	602,5
fondo	100x50	39.4x19.7	5	2,50	17,8	32	80,0	569,6
fondo plus	100x50	39.4x19.7	5	2,50	20,0	32	80,0	640,0
fondo plus	50x50	19.7x19.7	7	1,75	14,0	48	84,0	672,0
fondo	4,9x100	1.9x39.4	10	0,49	4,0	39	19,1	156,0
fondo plus	4,9x100	1.9x39.4	10	0,49	4,2	39	19,1	163,8
decoro bamboo	100x50	39.4x19.7	2	1,0	7,1	30	15,0	106,8
mosaico quadro	25x25	9.8x9.8	10	0,62	4,6	60	37,5	276,0
mosaico mattone	25x25	9.8x9.8	10	0,62	4,6	60	37,5	276,0
mosaico striscia	25x50	9.8x19.7	10	1,25	6,9	60	75,0	414,0
mosaico listello	25x50	9.8x19.7	10	1,25	6,9	60	75,0	414,0

**LEGENDA CODICI**  
CODE NOTICE  
LÉGENDE CODES  
ERLÄUTERUNG DES ARTIKELS  
LEYENDA CODIGOS

CODICE PREZZO	PRICE CODE	CODE PRIX	PREIS ARTIKEL NUMMER	CODIGO PRECIO
0000 materiale venduto al mq	0000 item sold by sqmt	0000 article vendu au m <sup>2</sup>	0000 artikel qm weise	0000 material vendido al mq
0000 materiale venduto al pz	0000 item sold by piece	0000 article vendu a la piece	0000 artikel stückweise	0000 material vendido a la pieza



iso 14001



iso 9001



emas

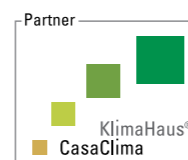

casaclima\*\*



leed\*



marchio CE

\* LEED  
 Lea Ceramiche, tramite la holding Panariagroup Industrie Ceramiche S.p.A., è socio ordinario del Green Building Council e del GBC Italia.  
 Through Panariagroup Industrie Ceramiche S.p.A., Lea Ceramiche is an ordinary member of the Green Building Council and the GBC Italia.  
 Par le biais de Panariagroup Industrie Ceramiche S.p.A., Lea Ceramiche est membre ordinaire du Green Building Council et du GBC Italia.  
 Lea Ceramiche, durch die Holding Panariagroup Industrie Ceramiche S.p.A., ist ordentliches Mitglied von dem Green Building Council und dem GBC Italien.  
 Lea Ceramiche, a través del holding Panariagroup Industrie Ceramiche S.p.A., es miembro afiliado del Consejo Construcción Verde y del Consejo Construcción Verde de Italia.

\*\* CASACLIMA  
 Lea Ceramiche, tramite la holding Panariagroup Industrie Ceramiche S.p.A., ha ottenuto la certificazione Partner Casaclima.  
 Through Panariagroup Industrie Ceramiche S.p.A., Lea Ceramiche has obtained the Partner Casaclima certification.  
 Par le biais de Panariagroup Industrie Ceramiche S.p.A., Lea Ceramiche a obtenu la certification Partner Casaclima.  
 Lea Ceramiche, durch die Holding Panariagroup Industrie Ceramiche S.p.A., hat die Bescheinigung als Partner Casaclima bekommen.  
 Lea Ceramiche, a través del holding Panariagroup Industrie Ceramiche S.p.A., ha obtenido la certificación Partner Casaclima.

# LEA

CERAMICHE

## LEA CERAMICHE

Via Cameazzo, 21  
41042 Fiorano Modenese  
Modena Italy

Tel +39 0536 837811  
Fax +39 0536 830326  
info@ceramichelea.it  
www.ceramichelea.com

Panariagroup Industrie Ceramiche S.p.A.

## SHOWROOM LEA CERAMICHE

Via Durini, 3  
20122 Milano

Tel +39 02 76011406  
showroom\_milano@ceramichelea.it

## LEA NORTH AMERICA, LLC

800 Clanton Road, Suite N  
Charlotte, NC 28217

Tel +1 704 522 6300  
Fax +1 704 522 6080  
info@leausa.us